

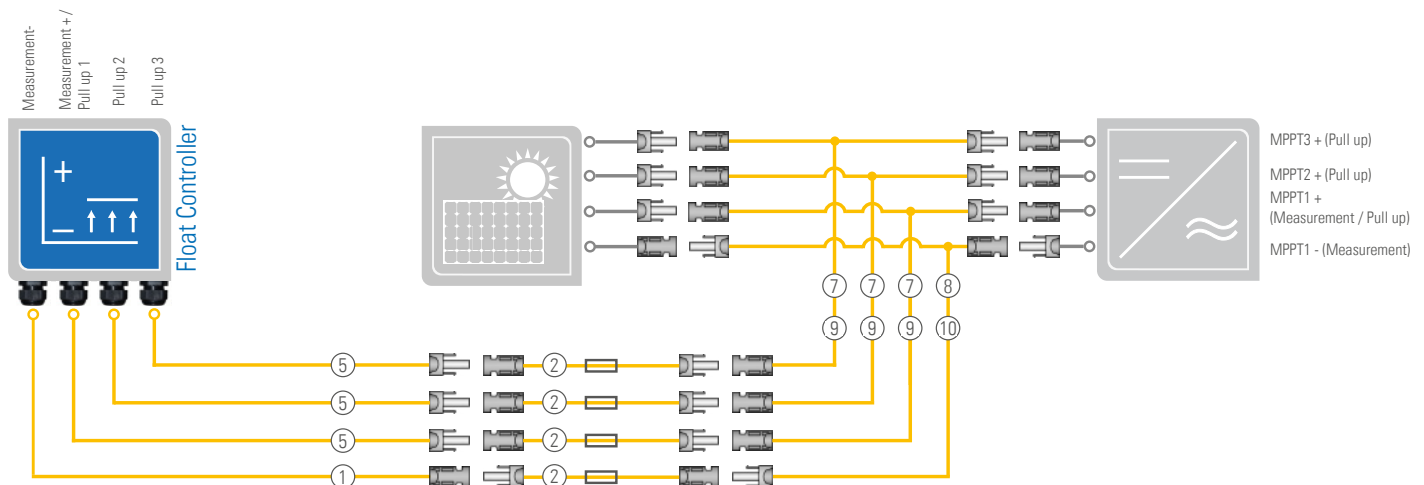







# Cable configurator

## PADCON Float Controller SI

### Float Controller



### Cable variants

Cable no.	Cable type	Length	Connections	Description
①		0,5m / 1,5m / 4m / 6m	open / plug MC4	Inverter connection cable (Measurement + / Pull up)
②		1m	socket MC4 / plug MC4	FC or MC connection cable with encapsulated 5A fuse (Module side with positive voltage )
⑤		0,5m / 3m / 5m / 10m	open / socket MC4	Distance cable (Measurement + / Pull up)
⑦		0,4m	plug MC4 / socket MC4 plug MC4	Y-cable +
⑧		0,4m	socket MC4 / plug MC4 socket MC4	Y- cable -
⑨		0,4m	Sunclix plug / socket MC4 Sunclix plug	Y- cable +
⑩		0,4m	Sunclix socket / plug MC4 Sunclix socket	Y- cable -

Please complete the form and send it to PADCON GmbH by e-mail, fax or post.

# Cable configurator

## PADCON Float Controller SI

### Order

---

Cable no.	Length	Amount

Cable no.	Length	Amount

Please complete the form and send it to PADCON GmbH by e-mail, fax or post.